

ETHER IO24 PIC R DIP

The Ether IO24 PIC R DIP is an integrated, micro-controller based network interface board with 24 digital user I/O lines. The module's firmware and hardware enable your devices or other modules to be connected to a generic Ethernet network and controlled using a command sent over the network via either TCP or UDP.

Each of the 24 User I/O lines operates at 5V DC maximum levels and can be independently programmed as an Input whose state can be remotely sensed via another network device, an Input whose state is internally checked and transmitted when a change occurs, or an Output whose state can be remotely controlled by another networked device.

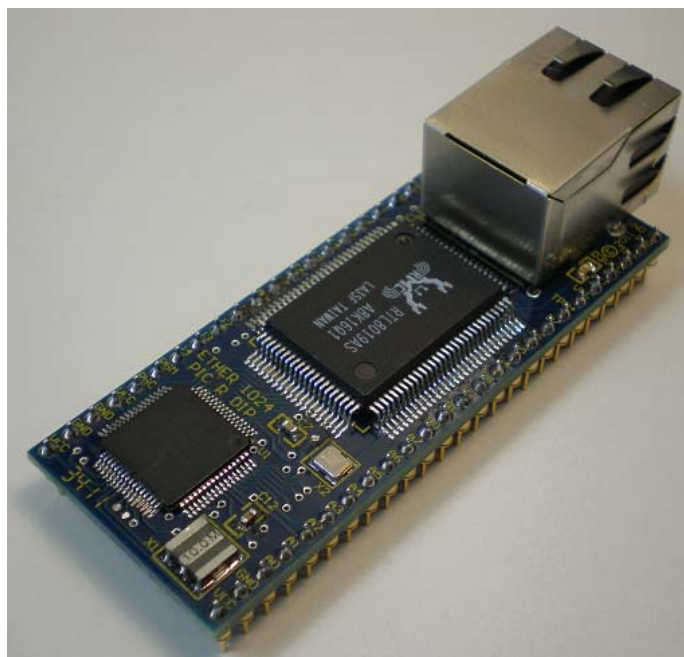

Module Features

- On-board Web Interface to configure and control the board
- Supports TCP and UDP Commands, ARP, BOOTP, DHCP, ICMP, HTTP
- Industry standard 10BaseT Ethernet Interface with an industry standard RJ-45 Connector
- 24 independently programmable signal lines with programmable pull-ups per line
- Compact module Fits into a standard 50-pin 900mil IC Socket (69mm x 25.2mm x 21mm) for easy prototyping
- Advanced configuration allows the modules to automatically scan the input ports and transmit changes directly to another ETHER I/O 24 module without host connection or to any Internet Port by router connection
- On board EEPROM allows all ports to power up in a user programmable state
- Programmable Fixed IP or Dynamic IP assignment from a DHCP server
- Small packet size and connectionless protocol allows for Real Time sensing and control
- Can be connected to a wireless network gateway or access point for wireless operation

Layout and Mechanicals

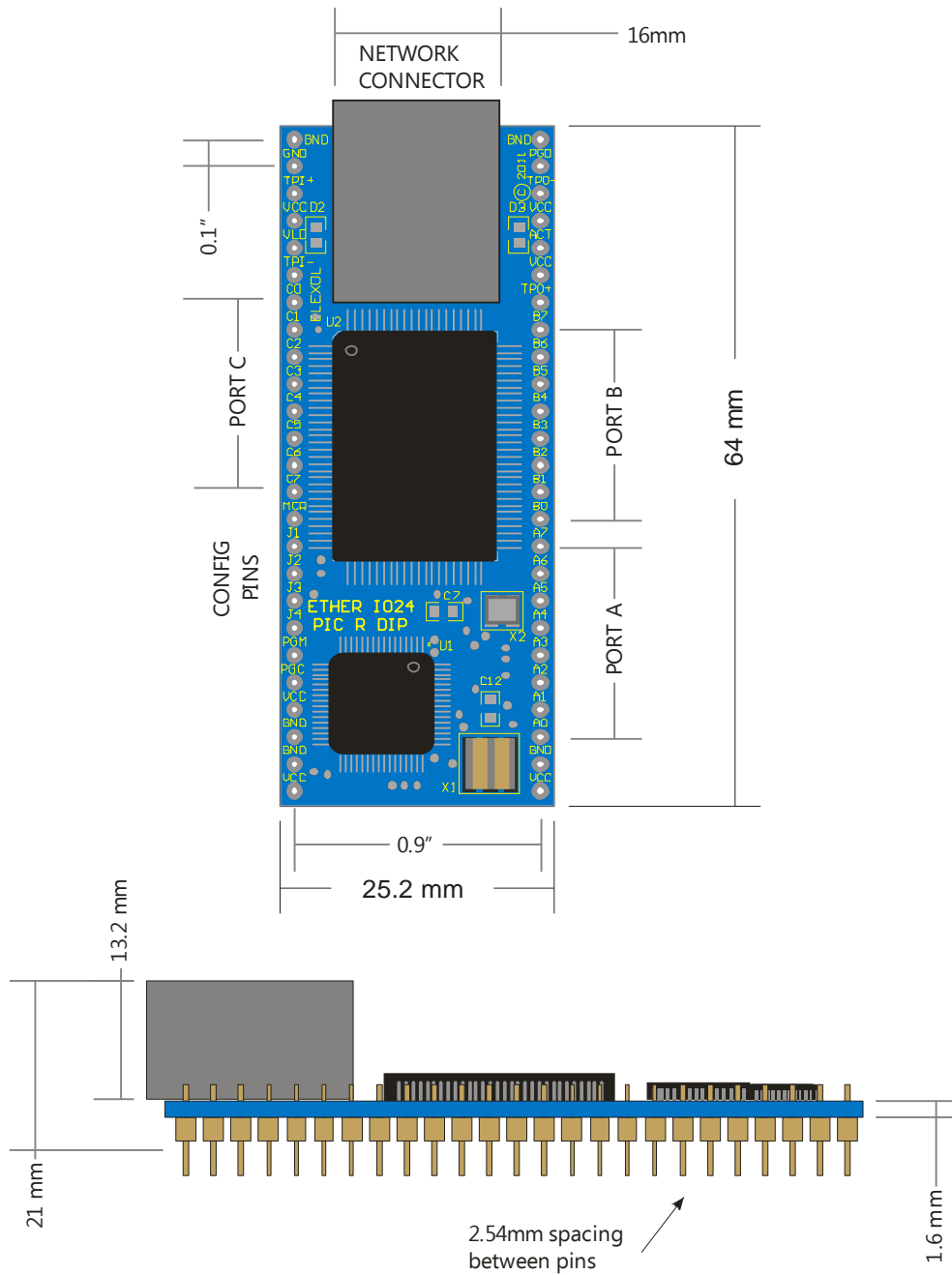

Pinouts and Board Connections

Ether IO24 PIC R DIP Pin out Tables

Power Pins for the Ether I/O 24 DIP R

PIN #	SIGNAL	TYPE	DESCRIPTION
1	GND	PWR	Device - Ground Supply Pin
2			
23			
24			
27			
50			
4	VCC	PWR	Device - Power Supply Pin 4.5 to 5V VCC supply to Ether I/O 24 PIC R DIP circuitry.
22			
25			
26			
45			
47			

Configuration Pins for the Ether I/O 24 DIP R

PIN #	SIGNAL	TYPE	DESCRIPTION
16	J1	IN	Tie to GND to lock the EEPROM memory from any write or erase procedures.
17	J2	IN	Tie to GND will cause the module to power up ignoring the user settings in the EEPROM; DHCP will be enabled and port will be set to 2424. When not tied to GND the user settings will be loaded from the EEPROM if the fixed IP address is enabled this IP address will be loaded else the unit will DHCP and load the port number programmed into the EEPROM. The unit is programmed with default Port Number 2424.
18	J3	IN	Tie to GND will disable DHCP and override the EEPROM IP address settings and force the module to used IP address 10.10.10.10 with Port 2424.
19	J4	IN	Tie to GND will disable DHCP and override the EEPROM IP address settings and force the module to used IP address 192.168.0.10 with Port 2424.

ICD3 Programming Pins

PIN #	SIGNAL	TYPE	DESCRIPTION
15	MCLR	-	
20	PGM	-	
21	PGC	-	
49	PGD	-	

I/O Connections (PORT A, B, C)

Listed below are the connections for the I/O connections on the Ether I/O 24 DIP R.

PORT A (Bi-Directional Data Bus pins)

PIN #	SIGNAL	TYPE	DESCRIPTION
35	A7	I/O	Programmable I/O pin with bit value of 128
34	A6	I/O	Programmable I/O pin with bit value of 64
33	A5	I/O	Programmable I/O pin with bit value of 32
32	A4	I/O	Programmable I/O pin with bit value of 16
31	A3	I/O	Programmable I/O pin with bit value of 8
30	A2	I/O	Programmable I/O pin with bit value of 4
29	A1	I/O	Programmable I/O pin with bit value of 2
28	A0	I/O	Programmable I/O pin with bit value of 1

PORT B (Bi-Directional Data Bus pins)

PIN #	SIGNAL	TYPE	DESCRIPTION
43	B7	I/O	Programmable I/O pin with bit value of 128
42	B6	I/O	Programmable I/O pin with bit value of 64
41	B5	I/O	Programmable I/O pin with bit value of 32
40	B4	I/O	Programmable I/O pin with bit value of 16
39	B3	I/O	Programmable I/O pin with bit value of 8
38	B2	I/O	Programmable I/O pin with bit value of 4
37	B1	I/O	Programmable I/O pin with bit value of 2
36	B0	I/O	Programmable I/O pin with bit value of 1

PORT C (Bi-Directional Data Bus pins)

PIN #	SIGNAL	TYPE	DESCRIPTION
14	C7	I/O	Programmable I/O pin with bit value of 128
13	C6	I/O	Programmable I/O pin with bit value of 64
12	C5	I/O	Programmable I/O pin with bit value of 32
11	C4	I/O	Programmable I/O pin with bit value of 16
10	C3	I/O	Programmable I/O pin with bit value of 8
9	C2	I/O	Programmable I/O pin with bit value of 4
8	C1	I/O	Programmable I/O pin with bit value of 2
7	C0	I/O	Programmable I/O pin with bit value of 1

LED / Ethernet Signals / No Connect Pins

PIN #	SIGNAL	TYPE	DESCRIPTION
5	VLD	IN	This pin will go active low when a valid command is received by the module. This pin is primarily used to function the valid command LED (D2)
46	ACT	IN	This pin is active low when the module is powered and the network interface is detected. The pin will go high whenever there is activity on the network.
3	TPI+	IN	This TP input pair receives the 10 M/bit/s differential Manchester encoded data from the twisted pair wire.
6	TPI-	IN	
44	TPO+	OUT	This TP output pair, outputs Manchester encoded signals which have been pre-distorted to prevent overcharge on the twisted pair wire.
48	TPO-	OUT	

Ethernet Connector

The module is equipped with a standard RJ45 network socket and conforms to the 10 Base-T standard. Only 4 of the 8 wires are used for network interface, 2 as a pair for data sent from the module and 2 as a pair for data being received by the module the other wires are unused at this time.

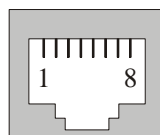

Ethernet Connector

PIN #	NAME	DESCRIPTION
1	TXD +	Transmit Data Positive Signal
2	TXD -	Transmit Data Minus Signal
3	RXD +	Receive Data Positive Signal
6	RXD -	Receive Data Minus Signal

Java Programming Interface

The Ether I024 PIC R DIP has an on board web interface that is used to configure all options for the module. This interface can be accessed via any java enabled web browser. The following section describes all features incorporated in the interface.

MODULE CONFIGURATION AND POWER UP SETTINGS USING THE WEB INTERFACE

Log-in Tab

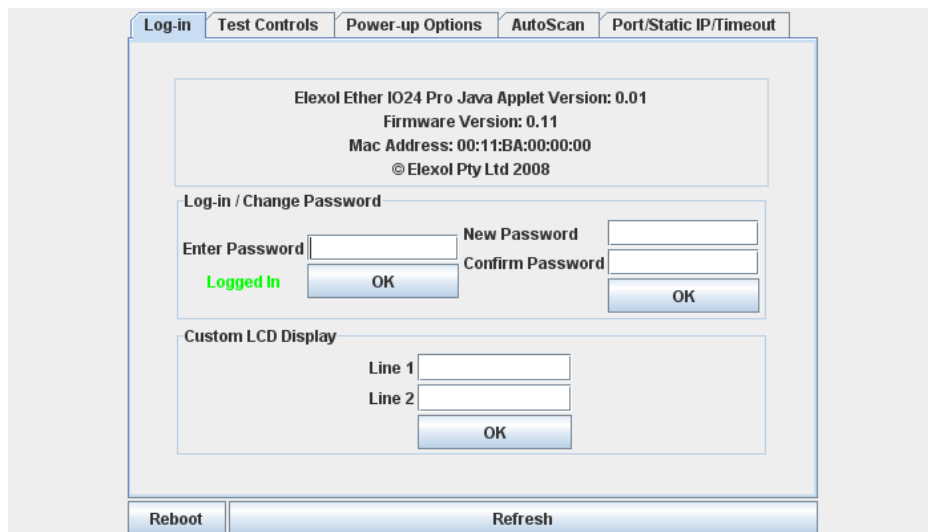

Log-in / Change Password

Enter Password to log-in. Factory default is a blank password. Once logged in, you can change the password.

Custom LCD Display (Only Applicable for Ether I024 PRO)

Use these fields to set a custom message on the upper, lower or both lines on the optional LCD display. To remove a custom message, simply enter a blank line.

Test Controls

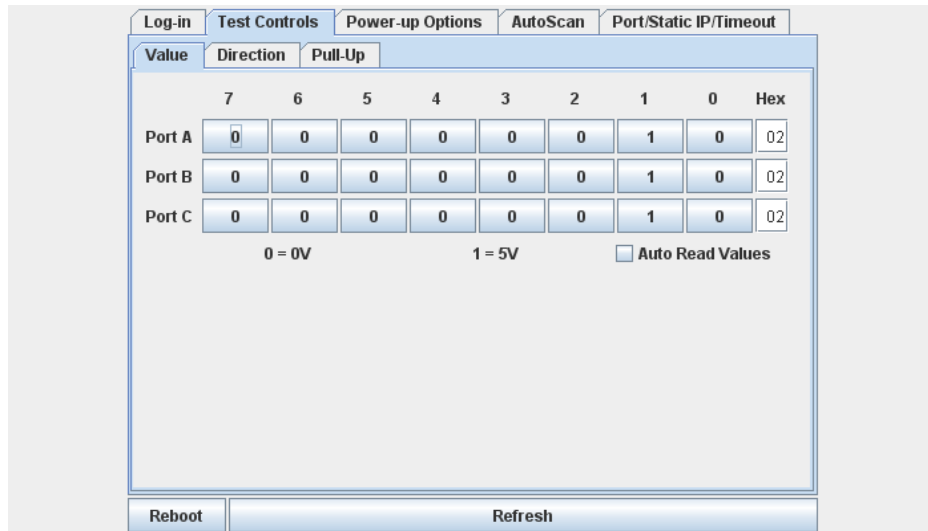

The screenshot shows a software interface with several tabs: Log-in, Test Controls (selected), Power-up Options, AutoScan, and Port/Static IP/Timeout. Under the Test Controls tab, there are sub-tabs for Value, Direction, and Pull-Up. The main area displays a table for three ports (A, B, and C) with 8 bits each (7-0) and a Hex column. Below the table are labels for 0 = 0V, 1 = 5V, and an unchecked checkbox for Auto Read Values. At the bottom are Reboot and Refresh buttons.

	7	6	5	4	3	2	1	0	Hex
Port A	0	0	0	0	0	0	1	0	02
Port B	0	0	0	0	0	0	1	0	02
Port C	0	0	0	0	0	0	1	0	02

0 = 0V 1 = 5V Auto Read Values

Reboot Refresh

Value

The port value is written to or read from the entire port with each of the value bits affecting the corresponding I/O line. The Auto read values check box when checked will constantly read Port A, B, C (poll) on the device to see if the pin has changed.

Direction

The Direction value of the port can be set as either input or output. When set as output, the I/O line will be driven to the last value written to the port. This value can be pre set by writing to the port before writing to the direction register.

Pull Up

The Pull Up configuration applies to those lines that are set as inputs, writing a 1 to the corresponding bit applies a pull up resistor to the line so that if it is not driven low it will be pulled to a known high state, this is very useful if sensing contact closures or open collector outputs

Power-up Options

The settings under the Power-up Options Tab relate to the various Port Modes of each of the Ports.

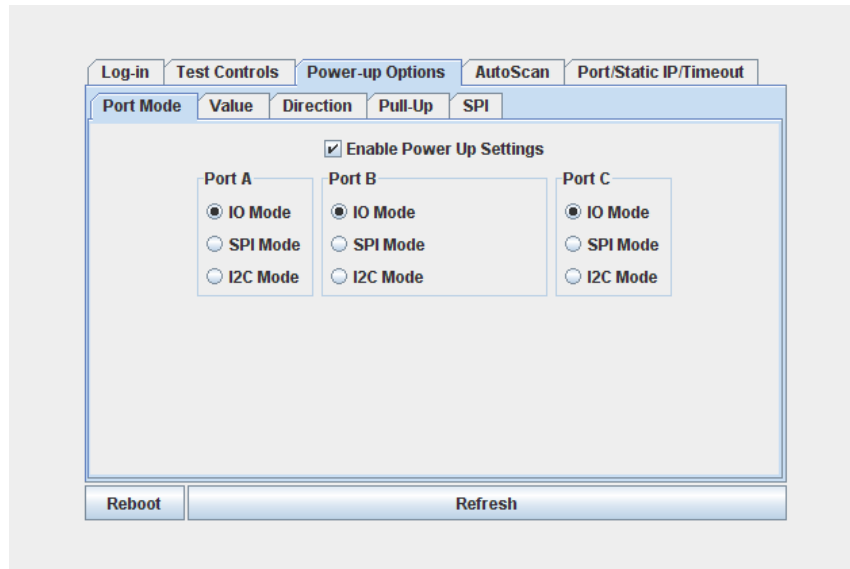

Enable Power-Up Settings

Uncheck this box if you want to disable the power-up settings. This will set default values for all the settings of the unit on power-up.

Port Modes

Sets the Port modes for each port. These modes include:

- IO Mode
This mode sets the Port to a standard Input/output port.
- SPI Mode
This mode configures the Port to transmit and receive SPI data from a connected SPI peripheral device.
- I²C Mode (Pronounced “I-squared-C”)
This mode configures the Port to transmit and receive I²C data from a connected I²C peripheral device.

Value, Direction and Pull-Up

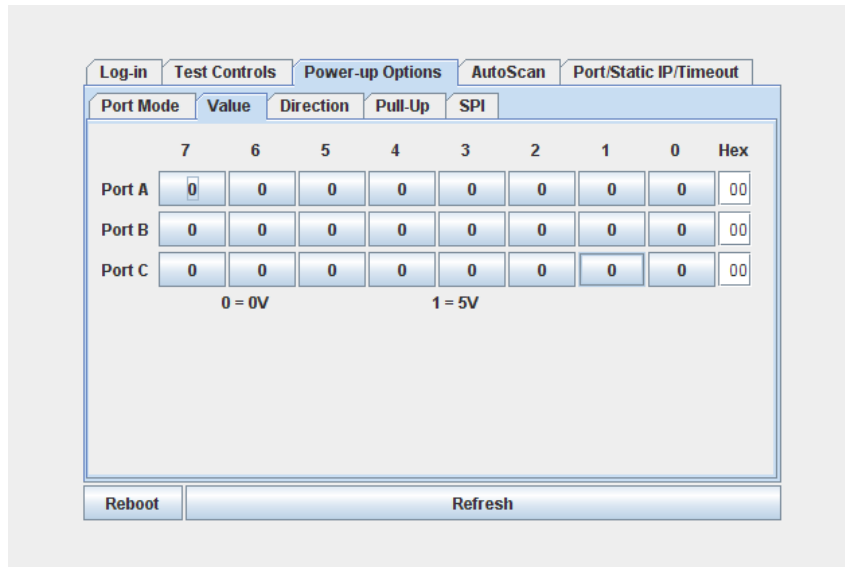

Port Mode	Value	Direction	Pull-Up	SPI									
					7	6	5	4	3	2	1	0	Hex
Port A	0	0	0	0	0	0	0	0	0	0	0	0	00
Port B	0	0	0	0	0	0	0	0	0	0	0	0	00
Port C	0	0	0	0	0	0	0	0	0	0	0	0	00

0 = 0V 1 = 5V

The module can be programmed to power up with all its ports to the pre-programmed state, thus if a machine needs to have certain devices enabled at power up or if the machine designer desires all lamps to light in a lamp test, it is possible for the module to accomplish this before the main control system is active. Listed below are the various settings that can be programmed for power up. Descriptions for these settings value, direction and pullup have been outlined in previous paragraphs of the manual.

SPI

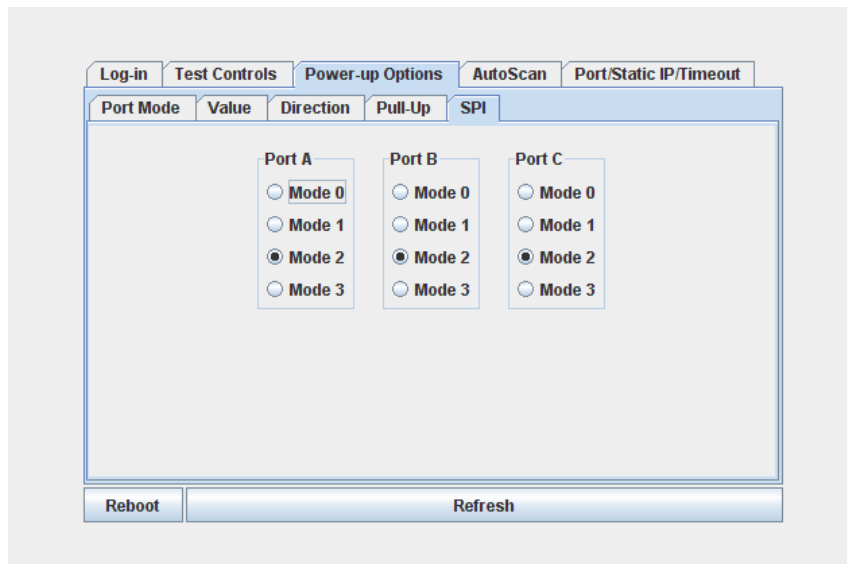

Set the SPI Mode of the Port to either of modes 0 to 3. These setting will only take effect if the respective port is set to SPI Mode.

AutoScan

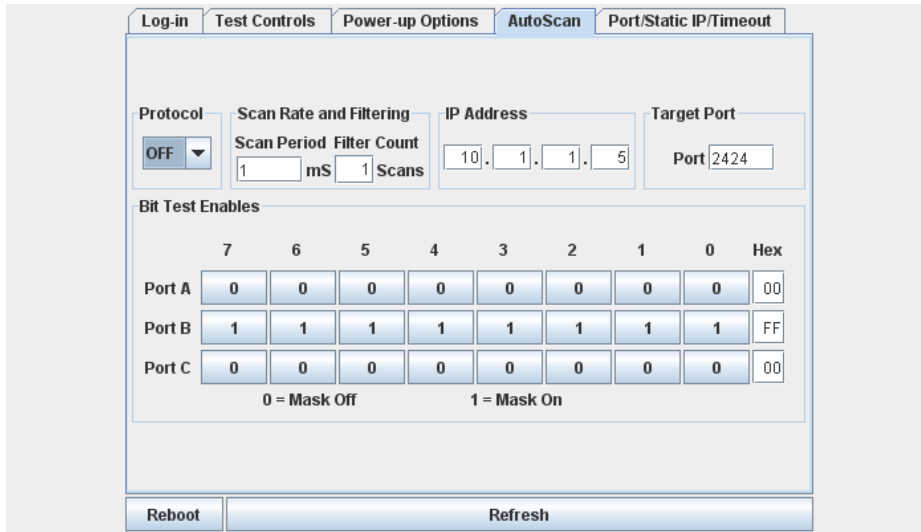

Bit Test Enables		7	6	5	4	3	2	1	0	Hex
Port A		0	0	0	0	0	0	0	0	00
Port B		1	1	1	1	1	1	1	1	FF
Port C		0	0	0	0	0	0	0	0	00

0 = Mask Off 1 = Mask On

The AutoScan mode will allow the module to originate communication with a remote device or another Ether IO24 module. This mode is very useful as it allows your software the freedom not to have to poll the module to check the state of the inputs

Protocol

Enables AutoScan and sets the Protocol to either UDP or TCP.

Scan Rate and Filtering

The Scan Rate is a 16-bit value which is used to divide the scan rate of the AutoScan mode from its base rate of 50 scans per second down to a user programmed rate from 25 scans per second to one scan per 54 minutes. When set at 1 the scan rate is 50 scans per second, it is 25 scans per second when the value is 2 and so on.

The filter value is used to count the number of identical reads that are required before a port value is considered valid and sent to the target device. When set at 0 the filter is turned off, when set at 1 the port must read the same for two scans to be considered valid and sent to the target. Higher numbers simply increase the number of identical reads required before the value is considered valid.

Care should be taken when using high filter values with slow scan rates, as the reporting time for a change under these conditions can be over 4 hours.

Target IP Address and Port Number

A Target IP Address and Port Number are provided to tell the Ether IO24 module what destination address the AutoScan data has to be sent too.

Bit Test Enables

Mask bits are used to allow some of the input pins to toggle without generating messages from the module. Any input whose corresponding mask bit is low, is ignored by the AutoScan function.

Port / Static IP / Timeout

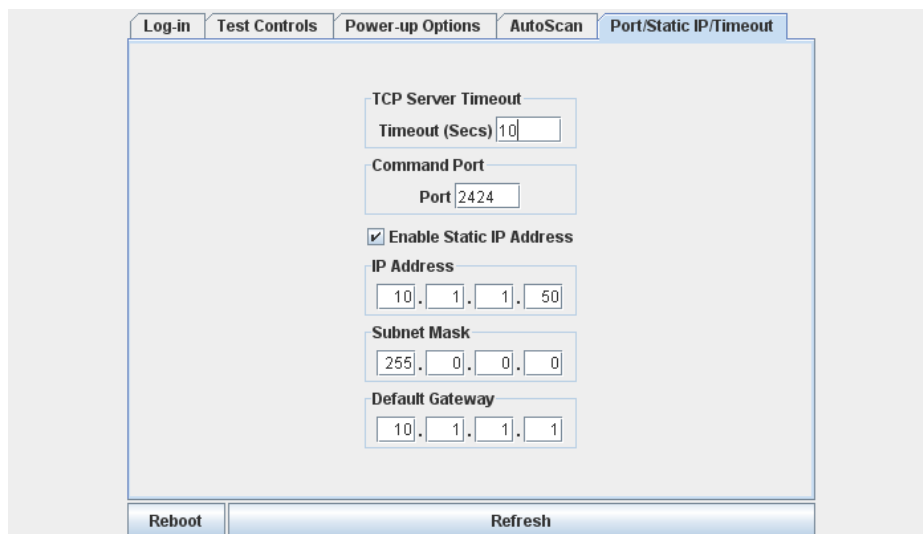

Log-in	Test Controls	Power-up Options	AutoScan	Port/Static IP/Timeout
TCP Server Timeout				
Timeout (Secs) 10				
Command Port				
Port 2424				
<input checked="" type="checkbox"/> Enable Static IP Address				
IP Address				
10 . 1 . 1 . 50				
Subnet Mask				
255 . 0 . 0 . 0				
Default Gateway				
10 . 1 . 1 . 1				
Reboot		Refresh		

TCP Server Timeout

Use this field to set the time (seconds), of inactivity on a TCP connection before the TCP Server closes the connection.

Command Port

Use this field to set the Command Port number. This number is the port that the unit will use to listen for UDP and TCP connections. The default port number is 2424.

Enable Static IP Address

Checking this box will disable the DHCP Client and assign the Unit with the Static IP Address, Subnet Mask and Default Gateway as specified in the fields below it.

Command Interface (Via TCP and UDP Packets)

The functions of the module are controlled by a command set that is sent via TCP or UDP packets. These TCP and UDP packets can be sent out from the PC via application software or from other Ether IO24 module if using AutoScan.

This section will cover in detail the command summary followed by the Command set used by the Ether IO24 PIC R DIP module.

Command Summary

The commands are displayed as followed:

- All commands are shown as ASCII characters, text in *italics* represent binary 1 byte values.
- Values that pertain to port Input, Output or control are shown as *data*,
- Values that pertain to address information are shown as *address*
- Where a specific byte requires its hexadecimal value it is shown as follows e.g. 0x55.
- The spaces shown are only for clarity and no actual spaces are used in commands sent to the module.
- The I/O lines are accessed as 3 ports and each line is controlled by its bit value within the data byte.

MODULE PORT CONFIGURATION

Each of the ports on the Ether IO24 PIC R DIP will need to be configured for the appropriate port mode configuration before sending commands to the unit. Care needs to be taken as different modes can affect the direction registers of the ports. The port mode can be set to either

- IO Mode
This mode sets the Port to a standard Input/output port.
- SPI Mode
This mode configures the Port to transmit and receive SPI data from a connected SPI peripheral device.
- I²C Mode (Pronounced "I-squared-C")
This mode configures the Port to transmit and receive I²C data from a connected I²C peripheral device.

The port mode can be changed via the web interface or by writing to the port mode EEPROM values for the configuration required. The default setting for the board will be IO MODE unless changed by the user.

Command Quick Reference

Table 1, Module Command Set

Command ASCII	Command Hex	Bytes	Data	Function	Response Bytes	Response Identifier	Response Data
I024	0x49 0x4F 0x32 0x34	4	-	Identify I024 Units	12	I024	6 Byte MAC Address 2 Byte Firmware Version
A	0x41	2	Port Value	Write Port A	-	-	-
B	0x42	2	Port Value	Write Port B	-	-	-
C	0x43	2	Port Value	Write Port C	-	-	-
a	0x61	1	-	Read Port A	2	A	Port A Value
b	0x62	1	-	Read Port B	2	B	Port B Value
c	0x63	1	-	Read Port C	2	C	Port C Value
!A	0x21 0x41	3	Direction	Write Port A Direction Register	-	-	-
!B	0x21 0x42	3	Direction	Write Port B Direction Register	-	-	-
!C	0x21 0x43	3	Direction	Write Port C Direction Register	-	-	-
!a	0x21 0x61	2	-	Read Port A Direction Register	3	!A	Direction
!b	0x21 0x62	2	-	Read Port B Direction Register	3	!B	Direction
!c	0x21 0x63	2	-	Read Port C Direction Register	3	!C	Direction
%A	0x25 0x41	3	Pull-Up	Write Port A Pull Up Register ¹	-	-	-
%B	0x25 0x42	3	Pull-Up	Write Port B Pull Up Register ¹	-	-	-
%C	0x25 0x43	3	Pull-Up	Write Port C Pull Up Register ¹	-	-	-
%a	0x25 0x61	2	-	Read Port A Pull Up Register ¹	3	%A	Pull-Up
%b	0x25 0x62	2	-	Read Port B Pull Up Register ¹	3	%B	Pull-Up
%c	0x25 0x63	2	-	Read Port C Pull Up Register ¹	3	%C	Pull-Up
H	0x48	2	Pin Number	Raise IO Pin	-	-	-
L	0x4C	2	Pin Number	Lower IO Pin	-	-	-
S				See Serial Communication Section below			
'r	0x27 0x72	4	AddMSB AddLSB	Read EEPROM Byte	4	r	AddMSB AddLSB Data
'w	0x27 0x77	5	AddMSB AddLSB Data	Write EEPROM Byte	-	-	-
'@	0x27 0x40	2	-	Reset Module	-	-	-

Bytes values include all Commands and Data sent in the packet
 - Means that there is no data or no response, do not insert data bytes

¹ Legacy Pull-up Command '@' is still implemented for backward compatibility, however it is advised to use the new command on any new development.

Overview of Command Set

Identify Ether IO 24 Units

Command Sent	ASCII Code	Bytes	Data	Function
	I024	4	-	Used to identify/find modules on the network and send specific module information (MAC address)
Command Reply	ASCII Code	Bytes	Data	
	I024	12	6 Bytes being the Modules' MAC Address 2 Bytes being the Modules' Firmware Version	

Operation: This Operation is used to find modules on the network as the module will respond to this command when broadcast. When this command is received, the Module's Information is sent back to the host, the module's IP Address can be obtained from the Source Address of the packet.

Write Port Value

Write Port A

ASCII Code	Bytes	Data	Function
A	2	<i>Port-Value</i>	Writes data to ports output lines. A bit value of 1 sets the corresponding line high and a 0 sets it low

The power up default value for this port is 0

Operation: This command affects any of the eight lines of Port A that are set as outputs. The port value is written to the entire port with each of the values bits affecting the corresponding I/O line. To change a single I/O line without affecting the others it is required to store the old value of the port or read its current value before writing a new value with only the corresponding bits changed. This command does not affect any I/O lines that are set as Inputs.

Write Port B

ASCII Code	Bytes	Data	Function
B	2	<i>Port-Value</i>	Writes data to ports output lines. A bit value of 1 sets the corresponding line high and a 0 sets it low

The power up default value for this port is 0

Operation: Same operation as Write Port A Register but implemented on Port B

Write Port C

ASCII Code	Bytes	Data	Function
C	2	<i>Port-Value</i>	Writes data to ports output lines. A bit value of 1 sets the corresponding line high and a 0 sets it low

The power up default value for this port is 0

Operation: Same operation as Write Port A Register but implemented on Port C

Read Port Value

Read Port A

		ASCII Code	Bytes	Data	Function
Command Sent		a	1	-	Sends the Value of Port A back to the host
	Command Reply		A	2	

Operation: The Value of the 8 I/O lines of Port A is read and sent back to the host. Those pins that are set as outputs are read as though they were inputs and their values sent back in the Port Value Byte.

Read Port B

		ASCII Code	Bytes	Data	Function
Command Sent		b	1	-	Sends the Value of Port B back to the host
	Command Reply		B	2	

Operation: The Value of the 8 I/O lines of Port B is read and sent back to the host. Those pins that are set as outputs are read as though they were inputs and their values sent back in the Port Value Byte.

Read Port C

		ASCII Code	Bytes	Data	Function
Command Sent		c	1	-	Sends the Value of Port C back to the host
	Command Reply		C	2	

Operation: The Value of the 8 I/O lines of Port C is read and sent back to the host. Those pins that are set as outputs are read as though they were inputs and their values sent back in the Port Value Byte.

Write Port Direction Register

Write Port A Direction Register

ASCII Code	Bytes	Data	Function
!A	3	<i>Direction</i>	Writes data to port's direction register. Lines with a corresponding bit value of 0 are set as outputs, lines with a bit value of 1 are set as inputs

The power up default for Direction is 255 setting all lines as inputs

Operation: This command affects all eight lines of port A. The Direction value is written to the entire port with each of the bits in the byte affecting the corresponding I/O line. To change a single I/O line without affecting the others it is necessary to store the old value of the port or read its current value before writing a new value with only the corresponding bits changed. To set the entire port as outputs use Direction = 0 to set all as inputs use Direction = 255 to set 0, 1, 2 and 3 as inputs and 4, 5, 6 and 7 as outputs use Direction = 15.

Write Port B Direction Register

ASCII Code	Bytes	Data	Function
!B	3	<i>Direction</i>	Writes data to ports direction register. Lines with a corresponding bit value of 0 are set as outputs, lines with a bit value of 1 are set as inputs

The power up default for Direction is 255 setting all lines as inputs

Operation: Same operation as Write Port A Direction Register but implemented on Port B

Write Port C Direction Register

ASCII Code	Bytes	Data	Function
!C	3	<i>Direction</i>	Writes data to ports direction register. Lines with a corresponding bit value of 0 are set as outputs, lines with a bit value of 1 are set as inputs

The power up default for Direction is 255 setting all lines as inputs

Operation: operation as Write Port A Direction Register but implemented on Port C

Read Port Direction Register

Read Port A Direction Register

	ASCII Code	Bytes	Data	Function
Command Sent	!a	2	-	Sends the Direction Register value back to the host
Command Reply	!A	3	<i>Register-Value</i>	

Operation: The Direction Register of Port A is read and its value sent back to the host.

Read Port B Direction Register

	ASCII Code	Bytes	Data	Function
Command Sent	!b	2	-	Sends the Direction Register value back to the host
Command Reply	!B	3	<i>Register-Value</i>	

Operation: The Direction Register of Port B is read and its value sent back to the host.

Read Port C Direction Register

	ASCII Code	Bytes	Data	Function
Command Sent	!c	2	-	Sends the Direction Register value back to the host
Command Reply	!C	3	<i>Register-Value</i>	

Operation: The Direction Register of Port C is read and its value sent back to the host.

Write Port Pull-up Register

Write Port A Pull Up Register

ASCII Code	Bytes	Data	Function
%A	3	<i>Enable</i>	Writes data to port's direction register. Lines with a corresponding bit value of 1 have their pull up resistors turned on, lines with a bit value of 0 have their pull up resistors turned off

The power up default for Enable is 0; all pull up resistors turned off

Operation: This command affects all eight lines of port A whose direction is set as an input. The Enable Value is written to the entire port with each of the bits in the byte affecting the corresponding I/O line. To change a single I/O line's behaviour without affecting the others it is necessary to store the old value of the register or read its current value before writing a new value with only the corresponding bits changed. To set the entire port with pull up resistors turned on use Enable = 255 or 0xFF to turn all the pull up resistors off use Enable = 0 or 0x00 to set 0, 1, 2 and 3 as on and 4, 5, 6 and 7 as off use Enable = 15 or 0x0F.

Write Port B Pull Up Register

ASCII Code	Bytes	Data	Function
%B	3	<i>Enable</i>	Writes data to port's direction register. Lines with a corresponding bit value of 1 have their pull up resistors turned on, lines with a bit value of 0 have their pull up resistors turned off

The power up default for Enable is 0; all pull up resistors turned off

Operation: Same operation as Write Port A Pull up Register but implemented on Port B

Write Port C Pull Up Register

ASCII Code	Bytes	Data	Function
%C	3	<i>Enable</i>	Writes data to port's direction register. Lines with a corresponding bit value of 1 have their pull up resistors turned on, lines with a bit value of 0 have their pull up resistors turned off

The power up default for Enable is 0; all pull up resistors turned off

Operation: Same operation as Write Port A Pull Up Register but implemented on Port C

Read Port Pull-up Register

Read Port A Pull Up Register

	ASCII Code	Bytes	Data	Function
Command Sent	%a	2	-	Sends the Pull Up Register value back to the host
Command Reply	%A	3	<i>Register-Value</i>	

Operation: The Pull Up Register of Port A is read and its value sent back to the host.

Read Port B Pull Up Register

	ASCII Code	Bytes	Data	Function
Command Sent	%b	2	-	Sends the Pull Up Register value back to the host
Command Reply	%B	3	<i>Register-Value</i>	

Operation: The Pull Up Register of Port B is read and its value sent back to the host

Read Port C Pull Up Register

	ASCII Code	Bytes	Data	Function
Command Sent	%c	2	-	Sends the Pull Up Register value back to the host
Command Reply	%C	3	<i>Register-Value</i>	

Operation: The Pull Up Register of Port C is read and its value sent back to the host

High/Low Commands

Raise IO Pin (High)

ASCII Code	Bytes	Data	Function
H	2	<i>IO Pin Number</i>	Raises the IO pin indicated by <i>IO Pin Number</i> (Numbered 0 to 23)

Operation: This command Raises the Pin Value on the IO Pin indicated in *IO Pin Number*. *IO Pin Number* is a number between 0 and 23 where Port A Pins correspond to 0 - 7, Port B Pins correspond to 8 - 15, and Port C Pins correspond to 16 - 23. The corresponding IO Pin must be set to Output for this command to have effect.

Lower IO Pin (Low)

ASCII Code	Bytes	Data	Function
L	2	<i>IO Pin Number</i>	Lower the IO pin indicated by <i>IO Pin Number</i> (Numbered 0 to 23)

Operation: This command Lowers the Pin Value on the IO Pin indicated in *IO Pin Number*. *IO Pin Number* is a number between 0 and 23 where Port A Pins correspond to 0 - 7, Port B Pins correspond to 8 - 15, and Port C Pins correspond to 16 - 23. The corresponding IO Pin must be set to Output for this command to have effect.

Read EEPROM

	ASCII Code	Bytes	Data	Function
Command Sent	'r	4	<i>AddMSB AddLSB</i>	The EEPROM data at <i>AddMSB:AddLSB</i> is read and sent back to the host
Command Reply	r	4	<i>AddMSB AddLSB Data</i>	

Operation: The module will read the EEPROM memory at the specified address and send a packet back to the host containing this data.

Note: The legacy command 'R', along with the original EEPROM addresses are still supported by the Ether IO24 PIC R however it is recommended that all new applications use the new 'r' command.

Write EEPROM

ASCII Code	Bytes	Data	Function
'w	5	<i>AddMSB AddLSB Data</i>	The <i>Data</i> value is written to the EEPROM address at <i>AddMSB:AddLSB</i>

Operation: The module will write the EEPROM memory at the specified Address with the data contained in the *Data* byte.

Special Conditions: The EEPROM cannot be written if the J1 pin is tied to GND.

Note: The legacy command 'W', along with the original EEPROM addresses are still supported by the Ether I024 PIC R however it is recommended that all new applications use the new 'w' command.

Reset Module

ASCII Code	Bytes	Data	Function
'@	2	-	The Module Resets

Operation: The module reset operation causes all the ports to be set to all inputs or as set up in the EEPROM and all EEPROM settings to be read and activated. When reset command is sent to the unit a 10ms delay should be allowed before sending any other commands to the unit.

Serial Communications Modes (Via I/O Ports)

Serial Communications Modes include SPI Mode and I2C Mode. The Port Mode is set as part of the Power-up Options in the Ether I024 PIC R DIP Java Applet. Once the Mode is set, all communications are done using the S Command as set out below.

SEND SERIAL DATA ON PORT A

Command Sent	ASCII Code	Bytes	Data	Function
	SA	2 + #data bytes + data	#data bytes + data	<p>Sends out Serial* data on PORT A. The number of data bytes is sent out first followed by the data. The return data will automatically be clocked in and sent back in the command reply.</p> <p>*Serial Data may be SPI or I2C, depending on Port Mode</p>
Command Reply (SPI Mode)	ASCII Code	Bytes	Data	
	SA	2 + #data bytes + data	Return data	
Command Reply (I2C Mode) ¹	ASCII Code	Bytes	Data	
	SA	2 + #data bytes + data	Data	

¹ I2C Mode only returns data on Read Commands.

Operation: Sends out Serial data on PORTA. The command consists of SA which tells the firmware that Serial data will be sent on PORTA, then the number of data bytes to be sent out followed by the data bytes. Below are some examples of the commands

SEND SERIAL DATA ON PORT B

	ASCII Code	Bytes	Data	Function
Command Sent	SB	2 + #data bytes + data	#data bytes + data	Sends out Serial* data on PORT B. The number of data bytes is sent out first followed by the data. The return data will automatically be clocked in and sent back in the command reply. * Serial Data may be SPI or I2C, depending on Port Mode
	ASCII Code	Bytes	Data	
Command Reply (SPI Mode)	SB	2 + #data bytes + data	Return data	
	ASCII Code	Bytes	Data	
Command Reply (I2C Mode) ¹	SB	2 + #data bytes + data	Return data	
	ASCII Code	Bytes	Data	

¹ I2C Mode only returns data on Read Commands.

Operation: Sends out Serial data on PORTB

SEND SERIAL DATA ON PORT C

	ASCII Code	Bytes	Data	Function
Command Sent	SC	2 + #data bytes + data	#data bytes + data	Sends out Serial* data on PORT C. The number of data bytes is sent out first followed by the data. The return data will automatically be clocked in and sent back in the command reply. * Serial Data may be SPI or I2C, depending on Port Mode
	ASCII Code	Bytes	Data	
Command Reply (SPI Mode)	SC	2 + #data bytes + data	Return data	
	ASCII Code	Bytes	Data	
Command Reply (I2C Mode) ¹	SC	2 + #data bytes + data	Return data	
	ASCII Code	Bytes	Data	

¹ I2C Mode only returns data on Read Commands.

Operation: Sends out Serial data on PORTC.

Overview of SPI Mode

The SPI interface that is implemented on the Ether I024 PIC R DIP is a very basic SPI master device that allows 4 different modes. The SPI mode only has the one clock speed which is mentioned below in the specifications. The SPI interface can be used to communicate with A/D, GPIO Expander, EEPROM chips to name a few. Shown in the diagram below is the typical connection of an SPI device to the Ether I024 PIC R.

Connection diagram between Ether I024 PIC R DIP Port A and an SPI device



Listed below are the SPI pin connections used by the Ether I024 PIC R DIP on all Ports.

- Port Bit 0 is Serial Clock (SCL) and will be set as an output when in SPI Mode
- Port Bit 1 is Serial Data Out (SDO) and will be set as an output when in SPI Mode
- Port Bit 2 is Serial Data In (SDI) and will be set as an input when in SPI Mode
- All other Port pins act as normal
- Any of the other pins can be used as SS or CS when SPI is used. CS pins can be active high or active low depending on the setup used.

SENDING BYTES VIA SPI

To send out SPI data on Port A the command that needs to be sent out requires an "SA" prefix followed by the number of bytes you want to send followed by the data stream. To send out the following bytes 0xFF 0xAA 0x55 you would send the following "SA" + 0x03 + 0xFF + 0xAA + 0x55

RECEIVING BYTES VIA SPI

Receiving bytes via SPI happens when the bytes are sent out, for every byte that is clocked out, there is an incoming byte being received. The number of bytes received is determined by the number of bytes that has been sent out.

In order to receive the number of bytes that is expected from the SPI device, Null bytes will have to be sent out. Sending out the Null bytes is required to keep the SPI clock running so that the return data is clocked out from the SPI slave device.

There are null bytes sent in the example image below, this can be seen in the last two bytes which are sent (implemented with don't cares) and on the input pin you will have the valid data from the device. The valid data will be sent back in the command response packet.

Note: you may have to send out leading zero's and don't cares depending on device you are communicating with. e.g. seven leading zero's then a start bit as per the image below.

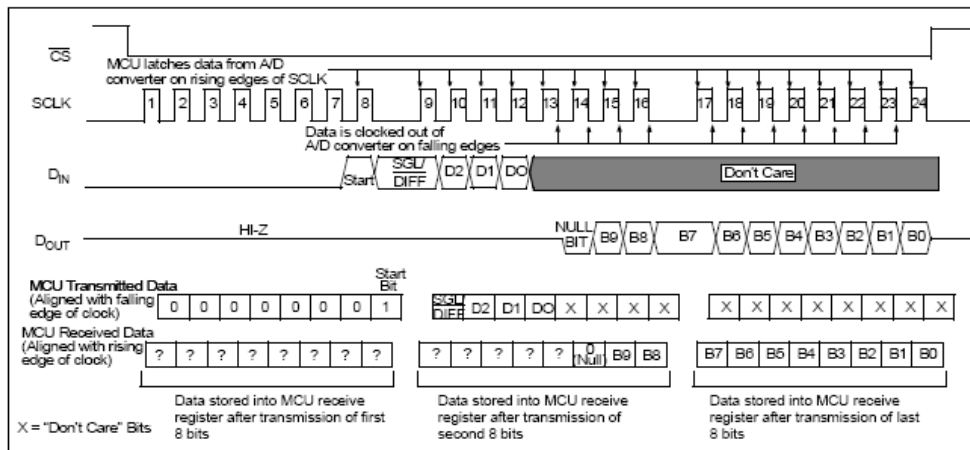

Example image for SPI communications with the MCP3004/3008 using 8 bit segments taken from the MCP3004./3008 datasheet.

(<http://www.microchip.com>)

BASIC OVERVIEW OF SERIAL COMMUNICATIONS TO SPI ACCESSORY BOARDS

Listed below is a basic overview of the procedure that needs to be followed in order to communicate with the board.

1. Configure the Port for SPI Mode using the Web-based Java Application.
2. Setup Port Values on Ether IO24 PIC R DIP for idle state on SPI Board
3. Lower the CS pin for chip communication
4. Start SPI communication by sending start byte
5. Send Control Byte or write command registers
6. Send Null Bytes if response is required. This is done to keep the SPI clock going or no responses will be clocked in
7. Raise the CS pin back to idle state.
8. Repeat from Step 3 for other commands.

The coding examples below go into more detail of what commands are issued to the board. In this case the commands outlined are for the Analog board.

SETTING UP THE PORT ON THE ETHER IO24 PIC R DIP FOR SPI COMMUNICATIONS TO THE ANALOG BOARD

Communication to the Analog board is via SPI from the port of Ether IO24 PIC R. However the port direction and pins will need to be setup before communication can begin with the board. Below are the configurations that need to be setup on the Ether IO24 PIC R DIP for the analog board.

I/O 24 COMMAND	DESCRIPTION
A 0x79	Set CS for A/D and D/A to idle state
A 0x71	Lower CS for A/D and D/A to idle state
A 0x78	Lower CS for D/A and A/D to idle state
A 0x38	Lower CS for D/A and set LDAC to high
A 0x68	Lower LDAC

SPI SPECIFICATIONS

The table below outlines the specifications of the SPI mode implemented on the Ether I024 PIC R.

SPI waveforms

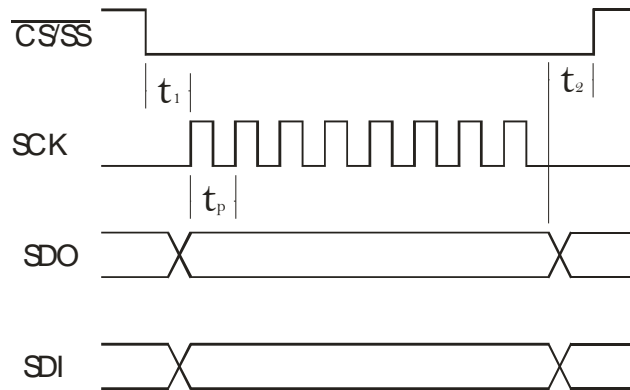

SPI Byte timing

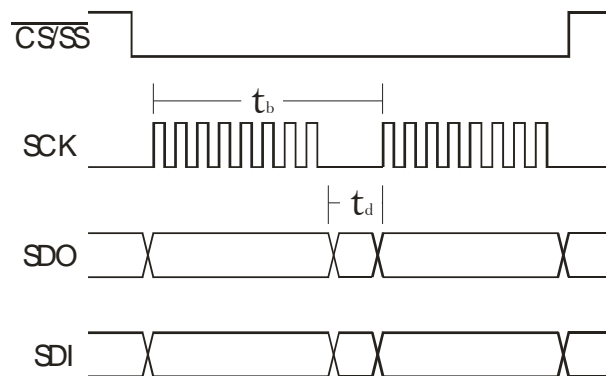

Symbol	Parameter	Min	Max	Units
t1	Time to First clock after CS has been lowered Max value is with CS in separate packet to SPI data	87us	2	mS
t2	Time to raise CS after last clock	42us	3.2	mS
tp	Clock Period	-	3	uS
tb	Time between start of bytes		45	uS
td	Time Between data bytes		22	uS

Overview of I²C Mode

The I²C interface that is implemented on the Ether I024 PIC R DIP is a very basic I²C master. The I²C mode only has the one clock speed which is mentioned below in the specifications. The I²C interface can be used to communicate with A/D, GPIO Expander, EEPROM chips to name a few. Shown in the diagram below is the typical connection of an I²C device to the Ether I024 PIC R.

Connection diagram between Ether I024 PIC R DIP Port A and an I²C device

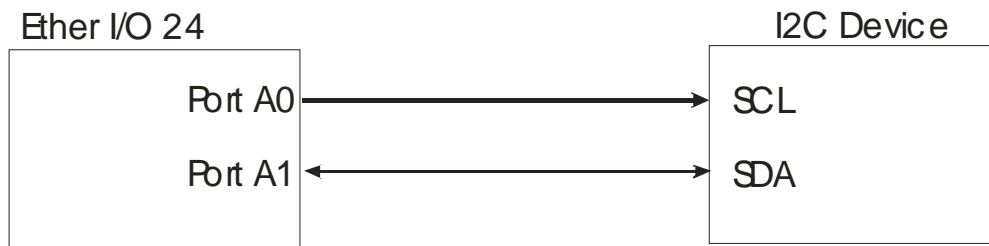

Listed below is the I²C pin connections used by the Ether I024 PIC R DIP on all Ports.

- Port Bit 0 is Serial Clock (SCL) and will be set as an output when in I²C Mode
- Port Bit 1 is Serial Data (SDA)
- All other Port pins act as normal
- Any of the other pins can be used for other functions when I²C is used.

I2C SPECIFICATIONS

The table below outlines the specifications of the I²C mode implemented on the Ether I024 PIC R.

Symbol	Parameter	Min	Max	Units
t1		us		mS
t2				mS
tp	Clock Period	60		uS
tb				uS
td				uS

AutoScan Configuration

The AutoScan mode will allow the module to originate communication with a remote device or another Ether I024 module. This mode is very useful as it allows your software the freedom to not have to poll the module to check the state of the inputs.

An overview of the AutoScan settings can be found in the AutoScan section of the Web Interface Chapter above.

Basic Functionality

Once AutoScan is configured, any input state changes on the configured port will automatically be sent to a host or another Ether I024 module.

The AutoScan response format is shown below:

AutoScan Response	Bytes	Data
* <i>Port Value</i>	3	<i>Port</i> is the module Port in which the state had changed <i>Value</i> is the new value of the port

The AutoScan packet is prefixed with a '*' to enable it to be differentiated from a normal read port return. For example, if Port A is configured for AutoScan, any input pin changes will be sent in the form:

*A[*New port value*]

Tips and tricks

- Auto scan will only work with values that are set to Inputs
- Don't leave floating input pins when using auto scan as the pins will change state and constantly send data. Tie them to a know state by using the in-built Pull-ups, or set them as outputs if not being used.
- The Auto scan packet sent back from the Ether I/O contains 3 bytes '*' 'Port Designator' 'Hex Port Value' e.g. *A0 data in packet UDP packet will be 2a 41 00
- Be sure to set the scan period and scan count appropriately for your application
- Use a program called Ethereal or WireShark to debug the packets being sent back and forth from the PC to the Ether I/O 24 and vice versa. (www.ethereal.com www.wireshark.org)
- Know what data is being sent back with the various commands sent. E.g. Sending I024 will return 12 bytes, Read command 2 bytes, etc

EEPROM Configuration

The EEPROM on the Ether I024 PIC R DIP is used to store the board's Serial number and other critical factory settings as well user settings for the module and there is even a spare area where you can store your own data to be kept by the module, even when the module loses power.

The EEPROM on the Ether I024 PIC R DIP is used to store the configuration settings for the board.

EE Address	Function	EE Address	Function
0 - 25	Reserved (Unwritable)		
26	DHCP Enable	27	Fixed IP Address Byte 1
28	Fixed IP Address Byte 2	29	Fixed IP Address Byte 3
30	Fixed IP Address Byte 4	31	Subnet Mask Byte 1
32	Subnet Mask Byte 2	33	Subnet Mask Byte 3
34	Subnet Mask Byte 4	35	Gateway IP Byte 1
36	Gateway IP Byte 2	37	Gateway IP Byte 3
38	Gateway IP Byte 4	39	Command Port LSB
40	Command Port MSB	41	TCP Server Timeout LSB
42	TCP Server Timeout BSB	43	AutoScan Enabled ¹
44	AutoScan Port A Mask	45	AutoScan Port B Mask
46	AutoScan Port C Mask	47	AutoScan Remote Port LSB
48	AutoScan Remote Port MSB	49	AutoScan Remote IP Byte 1
50	AutoScan Remote IP Byte 2	51	AutoScan Remote IP Byte 3
52	AutoScan Remote IP Byte 4	53	AutoScan Filter Count
54	AutoScan Period LSB	55	AutoScan Period MSB
56	Power-up Values Enabled	57	Power-up Port A Value
58	Power-up Port B Value	59	Power-up Port C Value
60	Power-up Port A Direction	61	Power-up Port B Direction
62	Power-up Port C Direction	63	Power-up Port A Pull-ups
64	Power-up Port B Pull-ups	65	Power-up Port C Pull-ups
66	Port A Mode	67	Port B Mode
68	Port C Mode	69	Port A SPI Mode
70	Port B SPI Mode	71	Port C SPI Mode
96 - 111	Custom Display Line 1 (16 Bytes)	112 - 127	Custom Display Line 2 (16 Bytes)

¹ AutoScan Enable: Setting this address to 0x01 will enable AutoScan in UDP mode. Setting it to 0x20 will enable AutoScan in TCP mode

Coding Examples

The example code has been written in Visual C# Express and are available for download from our website www.elexol.com

TCP INTERFACE EXAMPLES

Opening TCP Port and Connecting

```
//*****
//TCP Connect function opens TCP Connection to the device
//*****
private Boolean TCPConnect()
{
    if (client == null)
    {
        client = new TcpClient();

        //*****
        //Define device PORT as 2424
        //*****
        _devicePort = 2424;

        //*****
        //Define IP address that is to be used from textbox
        //*****
        _deviceIP = IPAddress.Parse(txtIPAddress.Text);

        //*****
        //Set up IP endpoint of Ether IO24 that you want to talk with
        //*****
        IPEndPoint serverEndPoint = new IPEndPoint(_deviceIP,
            _devicePort);

        //*****
        //Try and connect with Ether IO24
        //*****
        try
        {
            client.Connect(serverEndPoint); //Connect
            TestTextBox.AppendText("\r\n" + "~~~" + "\r\n");
            TestTextBox.AppendText("TCP Client Connected to " +
                _deviceIP + "\r\n");
            client.NoDelay = true;
        }
        catch (SocketException)
        {
            // Connection Failed
            return false;
        }
        return true;
    }
    else //If not connecting
    {
        try
        {
            client.Close();
            client = null;
            TestTextBox.AppendText("TCP Client Disconnected" + "\r\n");
        }
        catch (SocketException)
        {
            // Dis-connection Failed
        }
        return false;
    }
}
```

Closing TCP Connection

```

//*****
//TCP Disconnect function closes port
//*****
private void TCPDisconnect()
{
    client.Close();
    client = null;
    TestTextBox.AppendText("TCP Client Disconnected" + "\r\n");
}

```

Sending TCP Commands

SETTING PORT DIRECTION REGISTER AND PORT VALUE

```

//*****
//TCP Send Direction function sends command to device to set the
//Port Direction of PORT A to all output
//*****
private void TCPSendDirection_Click(object sender, EventArgs e)
{
    //*****
    //Open TCP Connection
    //*****
    if (!TCPConnect())
        return; //will kick out if not connected successfully

    //*****
    //Define variables that are to be used in routine
    //*****
    NetworkStream clientStream = client.GetStream();
    byte[] outBuffer = new byte[16];
    byte[] inBuffer = new byte[16];

    //*****
    //Send out Port Direction Command to the unit
    //*****
    outBuffer[0] = (byte)'!'; //Direction Command
    outBuffer[1] = (byte)'A'; //Port
    outBuffer[2] = (byte)0x00; //Value to be written to port direction register
    clientStream.Write(outBuffer, 0, 3);
    clientStream.Flush(); //Send out TCP packet

    //*****
    //Send out Port Command to the change value on Port
    //*****
    outBuffer[0] = (byte)'A';
    outBuffer[1] = (byte)0x55;
    clientStream.Write(outBuffer, 0, 2);
    clientStream.Flush();

    //*****
    //Disconnect TCP connection
    //*****
    TCPDisconnect();
}

```

READING PORT VALUE

```

/*****
//TCP Read Port function sends the command to the device,
//to read the Port and the Value on the Port
/*****
private void TCPReadPort_Click(object sender, EventArgs e)
{
    /*****
    //Define the Return Buffer for incoming data
    /*****
    byte[] ReturnDataBuffer = new byte[2];

    /*****
    //Open TCP Connection
    /*****
    if (!TCPConnect())
        return; //will kick out if not connected successfully

    /*****
    //Define variables that are to be used in routine
    /*****
    NetworkStream clientStream = client.GetStream();
    byte[] outBuffer = new byte[16];
    byte[] inBuffer = new byte[16];

    /*****
    //Send out Port Read Command to the unit
    /*****
    outBuffer[0] = (byte)'a';
    clientStream.Write(outBuffer, 0, 1);
    clientStream.Flush(); //Send out Command

    /*****
    //Implementation of Reading Port with Blocking
    //Function ReadPortValue only returns 2 bytes
    /*****
    ReturnDataBuffer = ReadPortValue(clientStream);

    /*****
    //Display the Port Value in the TextBox provided
    /*****
    TestTextBox.AppendText("Read Port " +
        System.Text.ASCIIEncoding.ASCII.GetString(ReturnDataBuffer,0,1) + " 0x"
        + ReturnDataBuffer[1].ToString("X2") + "\r\n");
    TestTextBox.AppendText("\r\n");

    /*****
    //Disconnect TCP connection
    /*****
    TCPDisconnect();
}

```

```

/*****
//TCP Read PortValue function Reads the icoming datastream from the device,
//the data returned is the Port and the Value
/*****
private byte[] ReadPortValue(NetworkStream clientStream)
{
    /*****
    // Define variables that are to be used in routine
    /*****
    byte[] inBuffer = new byte[2];
    byte inBufferCount = 0;

    System.Threading.Thread.Sleep(100); //wait

    /*****
    // Read 2 bytes back from stream (Port Read Response)
    /*****
    inBufferCount = 0;
    do
    {
        inBuffer[inBufferCount++] = (byte)clientStream.ReadByte();
    } while (clientStream.DataAvailable);

    /*****
    // Return the data that has been read back from Device
    // Should be Port and the Value
    /*****
    return inBuffer;
}
    
```

Receiving TCP Command Responses

TCP SERVER APPLICATION THAT HANDLES ALL INCOMING TCP TRAFFIC.

```

/*****
// Form_Load Method: Instantiate and start the listening thread
/*****
private void Form1_Load(object sender, EventArgs e)
{
    this.listenThread = new Thread(new ThreadStart(ListenForClients));
    this.listenThread.Start();
}
/*****
// ListenForClient() : This method runs in the listening thread.
// It will loop indefinitely waiting for a TCP Connection.
/*****
private void ListenForClients()
{
    try
    {
        this.tcpListener.Start();
    }
    catch
    {
        // Thread did not start.
    }

    while (true)
    {
        /*****
        // Blocks until a client has connected to the server
        /*****
        TcpClient client = this.tcpListener.AcceptTcpClient();
        System.Diagnostics.Debug.WriteLine("Client Connected");

        /*****
        // Create a thread to handle communication with connected client
        /*****
        Thread clientThread =
            new Thread(new ParameterizedThreadStart(HandleClientComm));
        clientThread.Start(client);
    }
}
    
```

```

//*****
// HandelClientComm()
// This method runs in the client thread.
// It will handle data coming from the client and loop until
// the client disconnects.
//*****
private void HandleClientComm(object client)
{
    TcpClient tcpClient = (TcpClient)client;
    NetworkStream clientStream = tcpClient.GetStream();

    byte[] message = new byte[4096];
    int bytesRead;

    while (true)
    {
        bytesRead = 0;

        try
        {
            //*****
            // Blocks until a client sends a message
            //*****
            bytesRead = clientStream.Read(message, 0, 4096);
        }
        catch
        {
            System.Diagnostics.Debug.WriteLine("catch");
            //*****
            // A socket error has occurred
            //*****
            break;
        }

        if (bytesRead == 0)
        {
            //*****
            // The client has disconnected from the server
            //*****
            System.Diagnostics.Debug.WriteLine("Client Disconnected");
            break;
        }

        //*****
        // Message has successfully been received
        //*****
        ASCIIEncoding encoder = new ASCIIEncoding();
        System.Diagnostics.Debug.WriteLine(encoder.GetString(message, 0,
            bytesRead));
    }
    tcpClient.Close();
}

```

UDP INTERFACE EXAMPLES

Sending UDP Commands

BROADCAST IO24

Shown below is example code for a button (Ether_Scan) that broadcasts "IO24" on port 2424

```
using System;
using System.Collections.Generic;
using System.ComponentModel;
using System.Data;
using System.Drawing;
using System.Linq;
using System.Text;
using System.Windows.Forms;
//*****
// Declare additional system-defined namespaces used by UDPClient
//*****
using System.Net.Sockets;
using System.Net;

namespace EtherIO24example
{
    public partial class Form1 : Form
    {
        //*****
        // Define variables that will be used throughout the code
        //*****
        public UdpClient udpClient = new UdpClient(2424);
        public byte[] sendBytes;

        public Form1()
        {
            InitializeComponent();
        }

        private void Ether_Scan_Click(object sender, EventArgs e)
        {
            //*****
            // Send out IO24 via broadcast(255.255.255.255) on port 2424
            //*****
            // Fill sendBytes buffer with "IO24"
            //*****
            sendBytes = Encoding.ASCII.GetBytes("IO24");

            //*****
            // Broadcast UDP packet with IO24 on port 2424
            // using the udpClient.send
            //*****
            udpClient.Send(sendBytes, //buffer
                sendBytes.Length, //buffer length
                "255.255.255.255", //destination IP
                2424); //destination Port
            //*****
            // All units will respond with IO24
            // + 6 byte MAC address + Version Number
            //*****
        }
    }
}
```

SETTING PORT DIRECTION REGISTERS AND PORT VALUES

The example code below shows the button code for setting the Port Direction register and the port values for PORT A on the Ether IO24 PIC R. The 'A' can be replaced with 'B' or 'C' depending on which port is being used.

SETTING PORT DIRECTION REGISTERS

```
private void Port_Direction_Click(object sender, EventArgs e)
{
    //*****
    // Declare buffer variable
    //*****
    byte[] buffer = new byte[5];

    //*****
    // Assign buffer values for command '!' + 'A' + port value
    //*****
    buffer[0] = Convert.ToByte('!'); //"!"
    buffer[1] = Convert.ToByte('A');//"A"
    buffer[2] = 0x64; //"0x48"

    //*****
    // Send out Command (!A 0x64) to 10.10.10.10 on port 2424
    //*****
    udpClient.Send(buffer,           //buffer
                   3,                //buffer length
                   "10.10.10.10",   //Destination IP
                   2424);           //Destination Port
}
```

SETTING PORT VALUES

```
private void Port_Value_Click(object sender, EventArgs e)
{
    //*****
    // Declare buffer variable
    //*****
    byte[] buffer = new byte[5];

    //*****
    // Assign buffer values for command 'A' + port value
    //*****
    buffer[0] = Convert.ToByte('A');//"A"
    buffer[1] = 0xFF; //"0xFF"

    //*****
    // Send out Command (A 0xFF) to 10.10.10.10 on port 2424
    //*****
    udpClient.Send(buffer,           // buffer
                   2,                // buffer length
                   "10.10.10.10",   // Destination IP
                   2424);           // Destination Port
}
```

Receiving UDP Command Responses

UDP LISTENER

This example program will broadcast I024 across the network on start up and list all Ether I024's that respond to the command in a drop down combo box.

```

using System;
using System.Collections.Generic;
using System.ComponentModel;
using System.Data;
using System.Drawing;
using System.Linq;
using System.Text;
using System.Windows.Forms;
//*****
// Declare additional system-defined namespaces used by UDPClient
//*****
using System.Net.Sockets;
using System.Net;

namespace UDPListener
{
    public partial class Form1 : Form
    {
        //*****
        // Define variables that will be used throughout the code
        //*****
        public UdpClient udpClient = new UdpClient(2424);
        public byte[] sendBytes;
        public byte[] data = new byte[1024];
        string PCIPAddress;
        public string strHostName;
        string ReturnIPAddress;
        List<IPEndPoint> IPList = new List<IPEndPoint>();
        public int DeviceNo, list;
        public IPEndPoint EtherIP;
        //*****
        // The thread that will manage the data back from the board
        //*****
        private System.Threading.Thread thdUDPReciever;

        //*****
        // This Subroutine is to handle all the UDP return data
        // recieved from the thread UDPReciever
        //*****
        public delegate void ReturnUDPDataCallback(byte[] text, IPEndPoint IP);

        public Form1()
        {
            InitializeComponent();
        }

        private void Form1_Load(object sender, EventArgs e)
        {
            //*****
            // Declare and start UDP recieve Thread
            //*****
            thdUDPReciever = new System.Threading.Thread(new
                System.Threading.ThreadStart(RecieveThread));
            thdUDPReciever.Start();

            //*****
            //Find out PC IP address as UDP Recieve thread
            //recieves all UDP packets
            //*****
            strHostName = System.Net.Dns.GetHostName();
            PCIPAddress =
                System.Net.Dns.GetHostEntry(strHostName).AddressList[0].ToString();
        }
    }
}

```



```

public void ReturnUDPData(byte[] UDPData, IPEndPoint RemoteIP)
{
    //*****
    //Declare Variables
    //*****
    string MacString;
    string VersionNumber;

    //*****
    //if 12 bytes were recieved in UDP Packet from the device
    //then we have recieved IO24 + MAC +Version
    //*****

    if ((UDPData.Length == 12))
    {
        if (this.comboBox1.InvokeRequired)
        {
            //*****
            //Need to invoke as the combobox and UDP reciever
            //is operating on different threads
            //*****
            ReturnUDPDataCallback d = new ReturnUDPDataCallback(ReturnUDPData);
            this.comboBox1.Invoke(d, new object[] { UDPData, RemoteIP });
        }
        else
        {
            //*****
            //Build up MAC string from the UDP data recieved
            //*****
            MacString = " MAC:" + Convert.ToString(UDPData[4], 16) + ":";
            MacString = MacString + Convert.ToString(UDPData[5], 16) + ":";
            MacString = MacString + Convert.ToString(UDPData[6], 16) + ":";
            MacString = MacString + Convert.ToString(UDPData[7], 16) + ":";
            MacString = MacString + Convert.ToString(UDPData[8], 16) + ":";
            MacString = MacString + Convert.ToString(UDPData[9], 16);
            MacString = MacString.ToUpper();

            //*****
            //Build up Version Number string from the UDP data recieved
            //*****
            VersionNumber = Convert.ToString(UDPData[10], 16) + ".";
            VersionNumber = VersionNumber + Convert.ToString(UDPData[11], 16);

            //*****
            //Add Ether IP address & MAC Address to combo box
            //*****
            this.comboBox1.Items.Add(RemoteIP.Address.ToString()
            + MacString + " V" + VersionNumber);
            this.comboBox1.SelectedIndex = comboBox1.Items.Count - 1;

            DeviceNo = comboBox1.SelectedIndex;
            EtherIP = IPList[DeviceNo];
        }
    }
}

```



```
private void Ether_Scan_Click(object sender, EventArgs e)
{
    //*****
    //Send out IO24 via broadcast(255.255.255.255) on port 2424
    //*****
    //fill sendBytes buffer with "IO24"
    //*****
    sendBytes = Encoding.ASCII.GetBytes("IO24");

    //*****
    //Broadcast UDP packet with IO24 on port 2424
    //using the udpClient.send
    //*****
    udpClient.Send(sendBytes, //buffer
                  sendBytes.Length, //buffer length
                  "255.255.255.255", //destination IP
                  2424); //destination Port
    //*****
    //All units will respond with IO24
    //+ 6 byte MAC address + Version Number
    //*****
}
}
```

READ PORT DIRECTION REGISTERS AND PORT VALUES

READ PORT A DIRECTION REGISTER

```
private void Read_DirA_Click(object sender, EventArgs e)
{
    //*****
    //Command data
    //*****
    data[0] = Convert.ToByte('!');//"! "
    data[1] = Convert.ToByte('a');//"a"

    //*****
    //Sending out Command Data
    //*****
    udpClient.Send(data, 2, EtherIP);

    //*****
    //we expect a response of 3 bytes back from unit
    //"!" + "A" + direction value of port A
    //this data will be captured
    //and then dealt with in ReturnUDPData
    //*****
}
}
```

READ PORT A VALUE REGISTER

```
private void Read_PORTA_Click(object sender, EventArgs e)
{
    //*****
    //Command data
    //*****
    data[0] = Convert.ToByte('a');//"a"

    //*****
    //Sending out Command Data
    //*****
    udpClient.Send(data, 1, EtherIP);

    //*****
    //we expect a response of 2 bytes back from unit
    //"A" + port value of port A
    //this data will be captured
    //and then dealt with in ReturnUDPData
    //*****
}
}
```

Absolute Maximum Ratings

Warning! Exceeding these ratings may cause irreparable damage to the unit.

Parameter	Absolute Maximum Conditions
Storage Temperature	-65°C to +150°C
Ambient Temperature (Power Applied)	-40°C to + 75°C
Power Input Voltage	+5.00v DC
DC Input Voltage - Inputs	-0.6v to +5.6v
DC Output Current - Outputs	45mA
DC Output Current - Total all outputs	210mA
Maximum DC current into an input pin	±500uA
Power Dissipation	3W

DC Characteristics (Temperature = 25°C, Power = 5VDC)

Parameter	Conditions	Min	Typ	Max	Units
DC Input				5.6	V
Power Consumption			1.1		W
Temperature Range		0		65	°C
Humidity Range		0		85	%RH
Logic Low Schmitt Trigger		0		0.75	V
Logic High Schmitt Trigger		4.25		5.0	V
Input Leakage Current	Vin = 0V or 5V	-3.0		+3.0	µA
Pull-Up Current		200	400	600	µA
Output High Voltage	Load = 14mA	4.3			V
Output Low Voltage	Load = 25mA			0.6	V

Packet Timing Characteristics

Due to the characteristics of different networks the expected time to receive and transmit packets to the unit will depend on the individual network configurations and the applications sending and receiving commands.

Parameter	Conditions	Min	Typ	Max	Units
Port Write Speed	Multiple writes within one packet		170		µS
Port Read Speed	Multiple reads within one packet		32		µS
Autoscan	Minimum Rate at which autoscan can pick up a pin toggle	10			mS

Further Reading

Information and coding examples for the Ether I024 PIC R DIP can be found on our website at www.elexol.com

Technical Support

For any questions relating to the Ether I024 PIC R DIP or if we can assist you with integrating the Ether I024 PIC R DIP into your own equipment please contact us by email at support@elexol.com

Document Revision History

- Ether I024 PIC R DIP Datasheet Revision 1 - Initial document created
- Revision 1.1 - Added AutoScan Section, Revised EEPROM Commands

Product Use Limitations, Warranty and Quality Statement

This product is not designed, intended, or recommended for use in systems intended to support or sustain life, or for any other application in which the failure of the product could create a situation where personal injury or death may occur and should not be used for those applications.

The Ether I024 PIC R DIP is warranted to be free from manufacture defects for a period of 12 months from the date of purchase. Subjecting the device to conditions beyond the Absolute Maximum Ratings listed in this document will invalidate this warranty. As the Ether I024 PIC R DIP is a static sensitive device, anti static procedures should be used in its handling.

All Ether I024 PIC R DIP units are tested during manufacture and are despatched free of defects.

Elexol is committed to providing products of the highest quality. Should you experience any product quality issues with this product please contact our quality assurance manager at the above address.

Disclaimer

This product and its documentation are provided as-is and no warranty is made or implied as to their suitability for any particular purpose. Elexol Pty Ltd will not accept any claim for damages arising from the use of this product or its documentation. This document provides information on our product and all efforts are made to ensure the accuracy of the information contained within. The specifications of the product are subject to change and continual improvement without notification.

Other than the extent permitted by law and subject to the Trade Practice Act, all and any liability for consequential loss or damage arising from

an Elexol Ether I024 PIC R DIP module is hereby limited, at discretion of Elexol Pty Ltd, to replacement or repair.